

McIntosh  
MR 78

# OWNER'S MANUAL

THE McINTOSH MR 78 SOLID STATE FM/FM STEREO TUNER





Your MR 78 FM/FM Stereo Tuner will give you many years of pleasant and satisfactory performance. If you have any questions concerning the operation or maintenance of this instrument, please contact:

## CUSTOMER SERVICE

McIntosh Laboratory Inc.  
2 Chambers Street  
Binghamton, New York 13903  
Phone: 607-723-3512

**Take Advantage of 3 years  
of FREE Factory Service . . .  
Fill in the Application NOW.**

# CONTENTS

GUARANTEE	1
INSTALLATION	2,3
HOW TO CONNECT	4,5
BACK PANEL INFORMATION	6
FRONT PANEL INFORMATION	6,7
LISTENING TO THE MR 78 TUNER	8
PERFORMANCE LIMITS	9
TYPICAL PERFORMANCE CHARTS	10,11
TECHNICAL DESCRIPTION	12,13,14
BLOCK DIAGRAM	15,16

## GUARANTEE

McIntosh Laboratory Incorporated guarantees this instrument to be capable of performance as advertised. We also guarantee the mechanical and electrical workmanship and components to be free of defects for a period of 90 days from date of purchase. If such defects occur, McIntosh Laboratory

or one of its authorized agencies will repair the defect at no cost to the purchaser. This guarantee does not extend to components damaged by improper use nor does it extend to transportation to and from the factory or service agency.

## THREE YEAR FACTORY SERVICE CONTRACT

An application for a FREE THREE YEAR FACTORY SERVICE CONTRACT is included with this manual. The terms of the contract are:

1. McIntosh will provide all parts, materials and labor needed to return the measured performance of the instrument to the original performance limits free of any charge. The SERVICE CONTRACT does not cover any shipping costs to and from the authorized service agency or the factory.
2. Any McIntosh authorized service agency will repair all McIntosh instruments at normal service rates. To receive the free service under the terms of the SERVICE CONTRACT, the SERVICE CONTRACT CERTIFICATE must accompany the instrument when taken to the service agency.
3. Always have service done by a McIntosh authorized service agency. If the instrument is modified or damaged, as a result of unauthorized repair the SERVICE CONTRACT will be cancelled. Damage by improper use or mishandling is not covered by the SERVICE CONTRACT.

4. The SERVICE CONTRACT is issued to you as the original purchaser. To protect you from misrepresentation this contract cannot be transferred to a second owner.
5. The SERVICE CONTRACT is given to purchasers who live in the 50 United States or Canada only.
6. For your protection McIntosh selects its dealers carefully. Only one dealer in ten qualifies for a McIntosh franchise. To receive the SERVICE CONTRACT your purchase must be made from a McIntosh franchised dealer.
7. Your completely filled in application for a SERVICE CONTRACT must be postmarked within 30 days of the date of purchase of the instrument.
8. To receive the SERVICE CONTRACT all information on the application must be filled in. The SERVICE CONTRACT will be issued when the completely filled in application is received at McIntosh Laboratory Incorporated in Binghamton, New York. If the application is not received at McIntosh Laboratory, only the service offered under the 90-day guarantee will apply.



clear any shelves, partitions or existing equipment located behind the panel. With the template in place mark the six "A" and "B" holes and four small holes locating the corners of the cutout. Next, join the four corner marks with pencil lines; the edge of the template may be used as a straight edge.

## 2. DRILL HOLES

Holding a drill perpendicularly to the panel, drill the six "A" and "B" holes using a 3/16 inch drill.

## THE SIX HOLES MUST BE DRILLED BEFORE MAKING THE CUTOUT.

## 3. SAW CUTOUT

Using a saw carefully cut the rectangular opening on **the inside** of the pencilled rectangle.

## 4. SECURE MOUNTING STRIPS

Secure mounting strips (supplied in the hardware package) on the inside of the cabinet panel.

Insert two screws (supplied in the hardware package) into the center holes ("B" holes on the template). Use the 3/4-inch long screws for panels under 1/2-inch or 1 1/4-inch screws for panels 1/2-inch thick or over. Place a mounting strip on the back of the cabinet panel as shown. Align it with the three holes in the panel and tighten the screw. The screw head should pull slightly into the wood panel. Attach the other mounting strip by repeating the procedure.

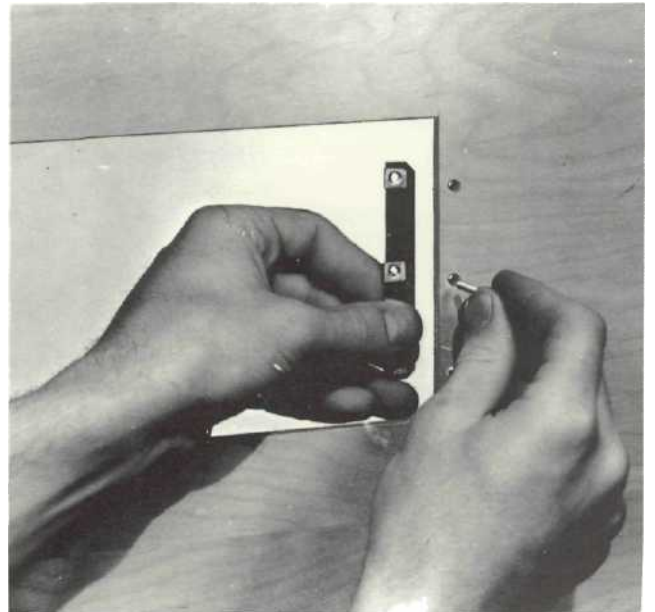

## 5. MOUNT PANLOC SHELF BRACKETS

Attach the Panloc shelf brackets to the cabinet panel using four screws of the proper length. Place the template over the mounting screws. The screws should be centered on the "A" and "B" holes in the template. If necessary, loosen the screws and push the mounting brackets into alignment then retighten.

## 6. INSTALL THE UNIT

Thread the power cord through the opening on the cabinet panel. Carefully slide the instrument into the opening so the rails on the bottom engage the

It is recommended that the MR 78 tuner be mounted in a normal or horizontal position. However, with adequate ventilation the tuner can be mounted in any position.

Adequate ventilation extends the trouble-free life of electronic instruments. It is generally found that each 18° F rise in operating temperature reduces the life of electrical insulation by one half. Adequate ventilation is an inexpensive and effective means of preventing insulation breakdown that results from unnecessarily high operating temperatures. The direct benefit of adequate ventilation is longer, trouble-free life.

The MR 78 tuner requires a mounting space that is at least 15 inches deep, 17 1/2 inches wide and 6 inches high. Provide additional space for the air flow across the bottom of the tuner and a means for warm air to escape at the top.

Remove the tuner, shelf brackets, parts bag and the mounting template from the carton. Remove tuner from the plastic bag and place the tuner upside down on the shipping pallet, then remove the four plastic feet fastened to the bottom of the chassis.

The installation may be accomplished in six easy steps.

## 1. POSITION TEMPLATE AND MARK

Position the plastic mounting template over the area of the cabinet panel where the MR 78 is to be installed. Be sure that the edges of the template



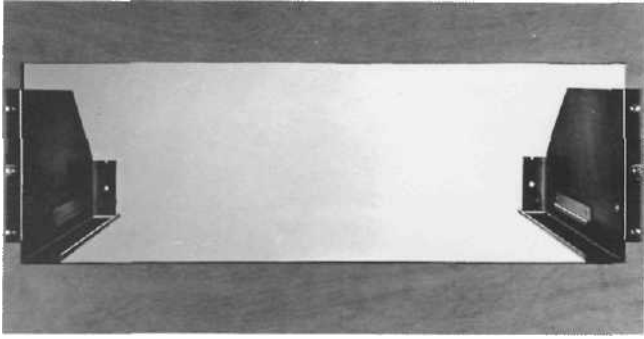

track on the mounting brackets. Slide the instrument in until it stops at the adjust position latches. Press the latches and continue to slide the instrument until its front panel is flush with the cabinet panel. At the bottom front corners of the instrument are the PANLOC buttons. Depressing the PANLOC buttons will lock the instrument firmly in the cabinet. Depressing the PANLOC buttons a second time (as with a ballpoint pen) will release the instrument. You can then slide the instrument forward to the adjust position. Depressing the adjust position latches will allow the instrument to be removed from the cabinet.



# How to Connect

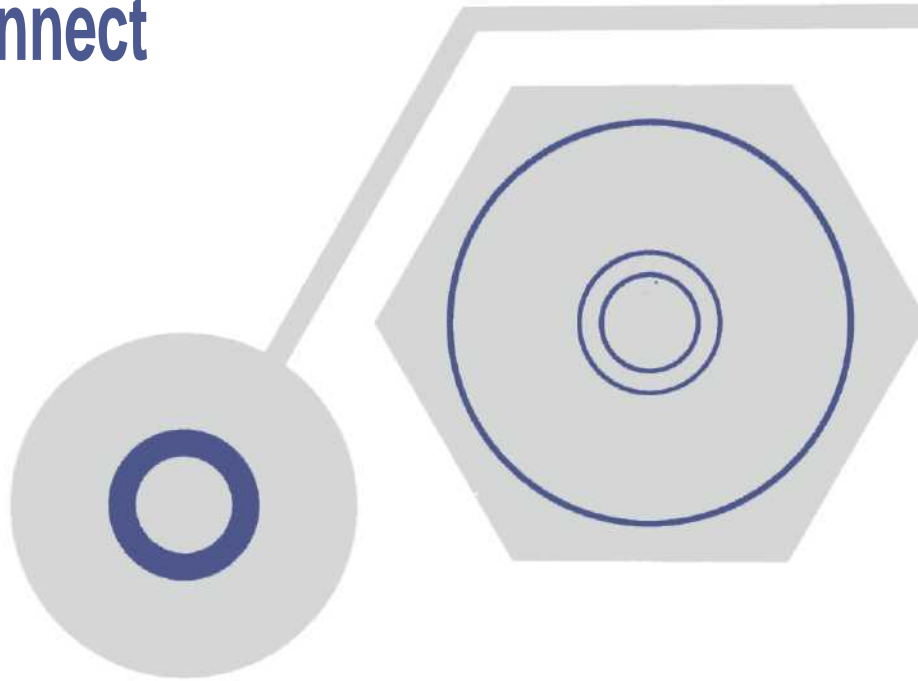

## AUDIO OUTPUTS

Use the FIXED OUTPUT jacks to connect to a stereo control preamplifier or other equipment which has its own volume control. The VOLUME CONTROL does not affect the output of the tuner at the FIXED OUTPUT jacks.

The output impedance at the FIXED OUTPUTS is 600 ohms. Longer cables than are normally supplied can be used to interconnect the MR 78 with other equipment. The length of the cable is limited by the capacity of the cable. The total capacity must not exceed 1600 pF. For instance: cables with a capacity of 32 pF per foot may be 50 feet long; 16 pF per foot cable may be 100 feet long.

Use the FRONT PANEL CONTROLLED jacks to connect to equipment such as power amplifiers or tape recorders where control of volume at the tuner is desired. The load impedance connected to the FRONT PANEL CONTROLLED jacks should not be less than 47,000 ohms. There is no difference in the signal quality or maximum output levels available at either pair of output jacks.

## CONNECTING AN FM ANTENNA

One of three antenna systems can be used: (1) an outdoor FM antenna, (2) an all channel (UHF-VHF-FM) antenna, or (3) the indoor dipole supplied with the MR 78.

An outdoor antenna is recommended for optimum performance in all areas. In fringe (outlying) areas, best results will be obtained with a highly directional FM antenna used in conjunction with a rotator. Rotate the antenna until the best reception is obtained. Connect the 300 ohm antenna to the 300  $\Omega$  ANT (red) terminals. A UHF-VHF-FM antenna is often effective but the antenna must be designed for both FM and TV reception. Connect the leads from the UHF-VHF-TV antenna to the 300 $\Omega$ ANT (red) terminals.

## CONNECTING AN INDOOR DIPOLE ANTENNA

The flexible folded dipole antenna (300 ohm) is for use in urban or high strength signal areas.

Connect the two leads from the dipole to the 300 $\Omega$  ANT (red) terminals. The flexibility of the thin flat wire assembly permits it to be placed under a rug, tacked behind the stereo . . . or, placed in any other convenient location. In some cases, it may be necessary to "position" the antenna for best signal reception. This should be done before it is permanently located. Avoid locating this antenna next to other wires or metal objects. This antenna may not prove effective in houses having metal siding or metal-clad insulation.

## CONNECTING A 75 OHM ANTENNA

An unbalanced 75 ohm antenna can be connected to the MR 78. A "type F" connector is used to connect the 75 ohm coaxial cable to the back panel 75  $\Omega$  ANT input.

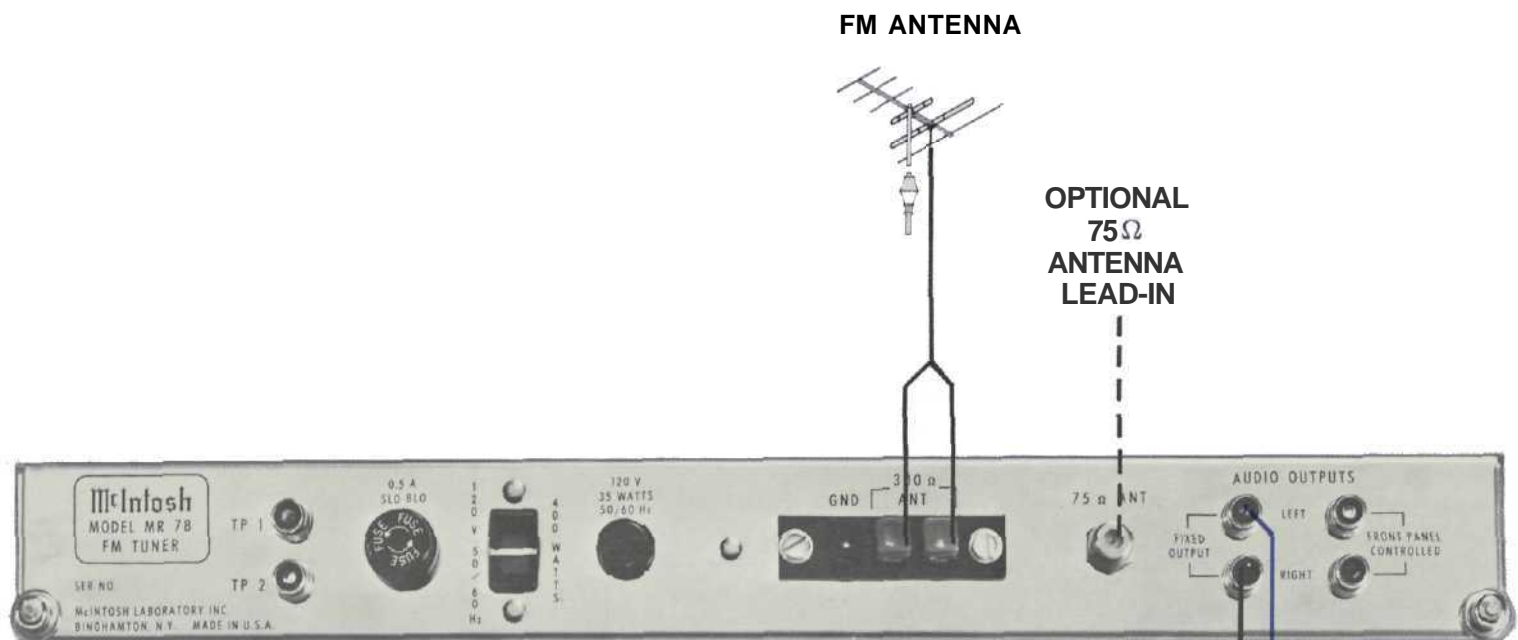

POWER AMPLIFIER

PREAMPLIFIER

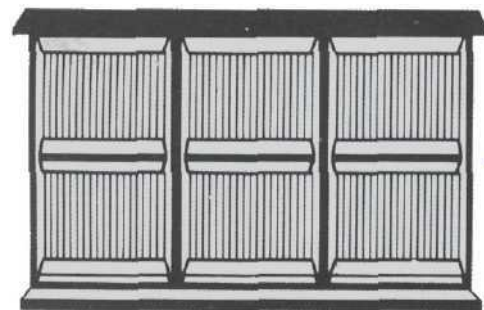
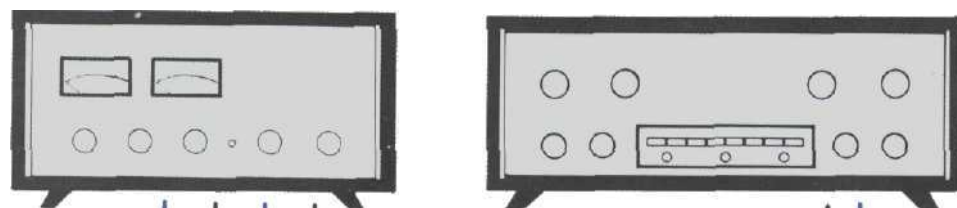

LEFT SPEAKER

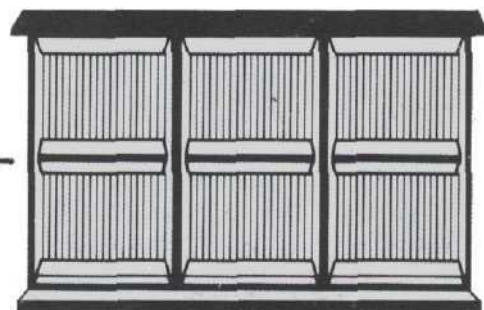

RIGHT SPEAKER

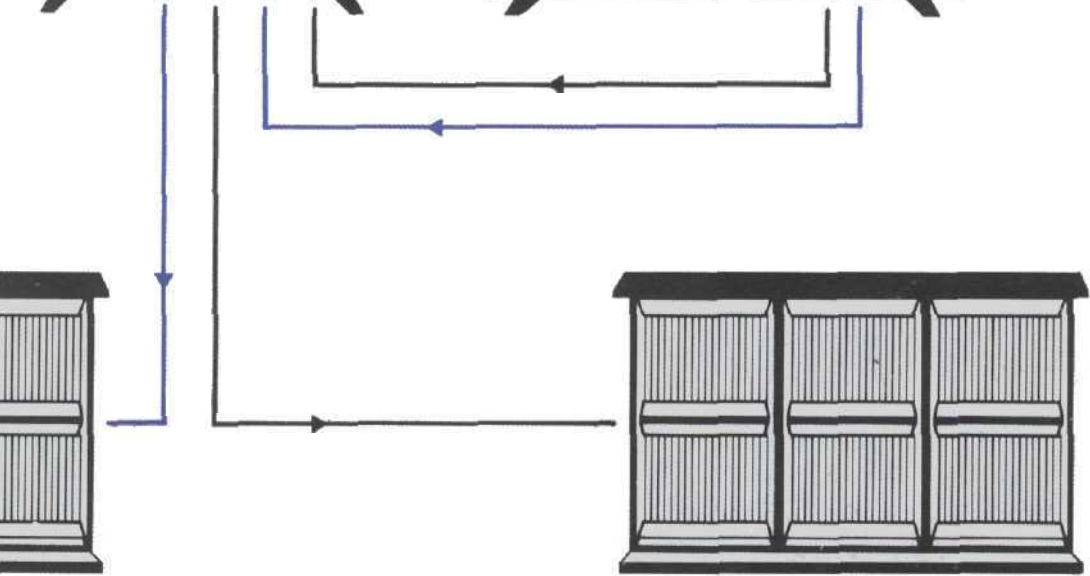

# Back Panel Information

## TP1 and TP2

Test points TP1 and TP2 are used with the McIntosh Maximum Performance Indicator.

## 120 V AC POWER OUTLET

Provides 120 volt AC power up to 400 watts for additional equipment such as amplifiers, etc. This outlet is not fused. It turns on and off with the front panel AC power switch on the VOLUME control.

## AC POWER CORD

Connect the AC power cord to a 120 volt, 50 to 60 Hz power line receptacle. The power used by the MR 78 is 35 watts.

## FUSE

A 0.5 AMP fuse protects the tuner circuits. This fuse does not protect additional equipment connected to the back panel AC power outlet.

## ANTENNA CONNECTION STRIP

Provides easy push type connectors for 300 ohm FM antenna and a ground connection.

## FM ANTENNA -75 OHM

Provides a "type F" connector for a 75 ohm unbalanced FM antenna.

## AUDIO OUTPUTS

The left-hand pair of AUDIO OUTPUT jacks provides FIXED OUTPUT audio signals. The program at these jacks is not affected by the MR 78 front panel VOLUME control. Use these output jacks to connect the tuner to a stereo control preamplifier or other equipment which has its own volume control.

The right hand pair of AUDIO OUTPUT jacks provides a FRONT PANEL CONTROLLED audio signal. The program at these jacks is controlled by the MR 78 front panel VOLUME control. Use these output jacks to connect to external power amplifier, tape recorders, or any equipment where continuous front panel control of tuner output volume is desirable.

It sets the output level of the tuner FRONT PANEL CONTROLLED AUDIO OUTPUT jacks. The FIXED OUTPUT jacks are not affected by the VOLUME control.

The AC power switch is part of the VOLUME control. Turning the volume control fully counterclockwise turns the AC power off.

## TUNING DIAL AND METER

The MR 78 has two dial scales:

1. FM scale - marked 88 to 108 MHz
2. Logging scale - marked 0 to 100

The logging scale can be used to accurately retune any station. You may find it easier to keep a record of your favorite stations by use of the logging scale. A small portion of the dial pointer has been illuminated to increase the ease of tuning. An FM station is tuned correctly when the TUNING meter pointer is in the black area of the meter scale. The tuning indication is independent of the station signal strength. Maximum left and right pointer swing, which occurs as you tune through a station, is dependent on the setting of the SELECTIVITY switch.

## STEREO FUNCTION INDICATOR

The STEREO FUNCTION indicator lights red when the dial pointer is tuned to or crosses a station broadcasting the 19,000 Hz pilot signal for stereo. The special circuit used will light only when the 19,000 Hz multiplex pilot is present. The indicator will not light on noise pulses or interference. The STEREO FUNCTION indicator will light regardless of the MODE switch setting.

## MODE SWITCH

The MODE switch has three settings.

**STEREO ONLY** - Only stations broadcasting the 19,000 Hz pilot signal for stereo can be heard in this position. All monophonic stations and background noises are suppressed. The TUNING meter and SIGNAL STRENGTH meter function will indicate monophonic broadcasts when tuning but no program will be heard from the loudspeakers.

**MONO**-In this position of the MODE switch, all broadcasts will be heard monophonically. The automatic stereo switching is bypassed. The STEREO FUNCTION indicator will light when a station is transmitting stereo, but the program heard from the loudspeakers will be mono.

**STEREO AUTO** - In this position of the MODE switch both mono and stereo broadcasts are heard. The tuner automatically switches from mono to stereo mode of operation, depending on the type of broadcast being received.

## MUTING SWITCH AND FUNCTION INDICATOR

Muting suppresses the background noise and hiss normally heard between stations. Turn the control

# Front Panel Information

The MR 78 Tuner has the most flexible control system ever designed in a stereo FM tuner. Use of these controls will give you a higher level of performance.

## VOLUME CONTROL AND AC POWER SWITCH

The VOLUME control has been precision tracked throughout the listening range (0 to -65 dB) for accurate stereo balance.





to either LOCAL or DISTANT position for muting. Weak stations that may not override noise and interference are also suppressed by the muting. In the OUT position, the muting is turned off. This allows tuning of weak stations, but the noise and interference will be present.

The MUTING FUNCTION indicator lights amber whenever the MUTING switch is set to DISTANT or LOCAL. It will extinguish when the MUTING switch is set to OUT.

#### **FILTER SWITCH and FUNCTION INDICATOR**

The FILTER SWITCH reduces noise on weak stereo stations.

- Position 1 reduces noise by approximately 10 dB.
- Position 2 reduces noise by approximately 20 dB.

The FILTER FUNCTION indicator lights green whenever the FILTER switch is set to 1 or 2. It does not light when the FILTER switch is set to OUT.

#### **SIGNAL STRENGTH/MULTIPATH SWITCH AND METER**

The SIGNAL STRENGTH/MULTIPATH meter can be switched to indicate either relative signal strength or relative amount of multipath interference. With METER switch set to SIGNAL STRENGTH, greater pointer deflection indicates a stronger signal.

With the METER switch set to MULTIPATH, there is little or no multipath interference when the meter indication remains steady and at the left end of the scale. If there is severe multipath interference, the meter indication will follow the audible signal in much the same manner as a VU meter. When the receiving antenna is rotated to minimize multipath interference, the meter indication will decrease and become steady. If the multipath interference is eliminated, the meter indication will be near zero and steady.

#### **SELECTIVITY SWITCH AND INDICATOR**

The SELECTIVITY switch allows stereo reception even under severe receiving conditions. Setting the

SELECTIVITY switch to NORMAL connects a very low distortion 8-pole Rimo filter in the IF circuit. Use the NORMAL position of the SELECTIVITY switch for listening to local broadcasts.

Setting the SELECTIVITY switch to NARROW adds a sharp 8-pole Rimo filter to the NORMAL IF filter to yield a low distortion (less than 0.2%), highly selective 16-pole composite IF filter. Use the NARROW position of the SELECTIVITY switch to reduce any interference during the reception of distant stations.

Setting the SELECTIVITY switch to SUPER NARROW adds a 4-pole 4-zero crystal filter to the two previously mentioned filters. Use the SUPER NARROW position to receive stations from distant cities which are on channels adjacent to local stations. There may be usable signals never heard before with ordinary FM tuners.

The SELECTIVITY indicator lights blue. The IHF Adjacent Channel Selectivity characteristics are: NORMAL 7 dB; NARROW 22 dB; and SUPER NARROW 55 dB.

#### **SECONDARY CONTROLS**

On the top of the chassis behind the front panel is the DIAL SCALE INTENSITY Switch and ANTENNA MATCH SELECTOR switch.

#### **DIAL SCALE INTENSITY SWITCH**

Adjust the brightness of the dial lights by means of this switch. Set the switch to BRIGHT for maximum panel light; set the switch to DIM for subdued dial light.

#### **ANTENNA MATCH SELECTOR SWITCH**

Under most conditions the ANTENNA MATCH SELECTOR switch should be set to HIGH GAIN ANT. position. Only in extreme fringe areas or when using a low-gain (indoor) antenna should this switch be set to LOW GAIN ANT. position. When set to LOW GAIN ANT. position, background noise on weak stations may be reduced.

# Listening to the MR 78 Tuner

## MONOPHONIC FM PROGRAMS

To receive monophonic FM broadcasts set the:

MODE switch to MONO  
MUTING switch to DISTANT  
FILTER switch to OUT  
SELECTIVITY switch to NORMAL

Adjust the tuning knob to the desired station. The station is properly tuned when the TUNING meter pointer comes to rest anywhere over the black area on the meter scale. While tuning across the dial you may notice movement of the tuning meter pointer without hearing a station. This is caused by a station so weak or distant that it does not over-ride the background noise. Extremely weak stations may be heard by setting the MUTING switch to OUT.

Rotate the directional antenna for best reception as indicated by a maximum pointer deflection on the SIGNAL STRENGTH meter and a minimum pointer deflection on the MULTIPATH meter. Then adjust the VOLUME control to the desired listening level.

## STEREO FM PROGRAMS

If you wish the tuner to automatically switch between stereo and mono broadcasts, set the:

MODE switch to STEREO AUTO  
MUTING switch to DISTANT  
SELECTIVITY switch to NORMAL

In this mode of operation, setting the FILTER switch to position 1 or 2 will reduce noise on weak stereo stations.

When the STEREO indicator is lighted, the station is broadcasting a 19,000 Hz pilot signal for stereo and the

MR 78 will automatically switch to stereo. If a station is not transmitting the 19,000 Hz pilot for stereo, the STEREO indicator will remain off and the tuner will automatically switch to mono.

When the MODE switch is set to STEREO ONLY, monophonic broadcasts and background noise between stations will be muted. Broadcasts with the 19,000 Hz pilot signal will activate an automatic stereo sensing circuit. The stereo indicator will light and the broadcast will be heard.

## USING VARIABLE SELECTIVITY

With the increasing number of stations crowding the FM broadcast band, an FM tuner with variable selectivity has become a necessity. Local stations are received best with the SELECTIVITY switch in the NORMAL position. This position gives the lowest distortion. Use this position for critical taping of live local broadcasts.

If you experience "crosstalk" or "splatter" on a signal from a strong adjacent or alternate channel, use the NARROW position of the SELECTIVITY switch to reduce the interference.

The "SUPER NARROW" SELECTIVITY position is used to find clear signals from distant stations that cannot be heard from ordinary tuners.

When you use SUPER NARROW SELECTIVITY, you may find that reception of distant stations adjacent to a channel transmitting SCA (background music programs) is difficult. Stations transmitting SCA often have wide sidebands. These sidebands spill over onto adjacent channel stations. If you tune the MR 78 to one of the sidebands of the SCA transmission, you may be able to hear the background music program simultaneously with the regular program.



# Performance Limits

**PERFORMANCE GUARANTEE** - Performance limits are the maximum deviation from perfection permitted for a McIntosh instrument. We promise you that the MR 78 you buy must be capable of performance at or exceeding these limits or you get your money back. McIntosh is the only manufacturer that makes this guarantee.

**TUNING RANGE:** 88 to 108 MHz

**ANTENNA INPUTS:** 300 ohms balanced; 75 ohms unbalanced

**INTERMEDIATE FREQUENCY (IF):** 10.7 MHz

**SENSITIVITY:** 2 $\mu$ V for 35 dB of quieting; 2.5 $\mu$ V at 100% modulation ( $\pm$ 75 KHz deviation) for 3% total noise and harmonic distortion.

**SIGNAL TO NOISE RATIO:** 75 dB below 100% modulation.

**HARMONIC DISTORTION:** 0.2% mono or stereo at 100% modulation to 15,000 Hz. Typically, 0.05% at 1,000 Hz

**DRIFT:** 25,000 Hz for the first two minutes; thereafter 5,000 Hz at 25°C in 24 hours.

**FREQUENCY RESPONSE:** MONO -  $\pm$ 1 dB 20 Hz to 20,000 Hz with standard de-emphasis, (75 $\mu$ S); STEREO -  $\pm$ 1 dB 20 Hz to 15,000 Hz with standard de-emphasis <75 $\mu$ S)

**CAPTURE RATIO:** 0.25 dB detector only; 2.5 dB complete tuner

**SELECTIVITY:** IHF

SELECTIVITY SWITCH SETTING

	NORMAL	NARROW	SUPER NARROW
Adjacent Channel	7 dB	22dB	55dB
Alternate Channel	55dB	80dB	80dB

**SUPURIOUS REJECTION:** 100 dB IHF

**IMAGE REJECTION:** 100 dB, 88 to 108 MHz. IHF

**INTERMODULATION DISTORTION:** 0.2% mono or stereo for any combination of frequencies from 20 Hz to 15,000 Hz with peak modulation equal to 100% or less. Typically 0.1%

**MAXIMUM SIGNAL INPUT:** 12 volts across 300 ohm antenna terminals will not increase harmonic or intermodulation distortion

**AUDIO HUM:** 70 dB down from 100% modulation

**MUTING:** 70 dB noise reduction between stations

**MUTING THRESHOLD (Typical):** Distant position 5 $\mu$ V; Local position 20 $\mu$ V

**SCA FILTER:** 50 dB down from 67 KHz to 74 kHz; 275 dB per octave slope

**STEREO SEPARATION:** 40 dB at 1,000 Hz

**STEREO FILTER (Typical):** 10 dB noise reduction in Position 1.

20 dB noise reduction in Position 2.

**AUDIO OUTPUT:** Front Panel Controlled: 2.5 volts into 47,000 ohms.

Fixed Output: 2.5 volts into 47,000 ohms; 1.0 volt into 600 ohms.

All tuner performance limits were measured with SELECTIVITY switch set at NORMAL, unless otherwise stated.

## GENERAL INFORMATION

**POWER REQUIREMENT:** 120 volts, 50/60 Hz 35 watts

**SEMICONDUCTOR COMPLEMENT:** 3 JFET's, 2 MOSFET's, 17 Bipolar Transistors, 43 Diodes, 4 Integrated Circuits

## MECHANICAL INFORMATION

**SIZE:** Front Panel: 16 inches wide (40.65 cm) by 5-7/16 inches high (13.8 cm); Chassis: 15 inches wide (38.1 cm) by 13 inches deep (33.1 cm), including PANLOC shelf and back panel connectors; Knob clearance" 1-1/2 inches (3.85 cm) in front of mounting panel.

**WEIGHT:** 27 pounds (12.25 kg) net, 39 pounds (17.69 kg) in shipping carton.

**FINISH:** Front panel: Anodized gold and black with special gold/teal panel nomenclature illumination; Chassis: Chrome and black

**MOUNTING:** McIntosh developed professional PAN-LOC

# Typical Performance Charts

IF SELECTIVITY AND TIME DELAY CHARACTERISTICS

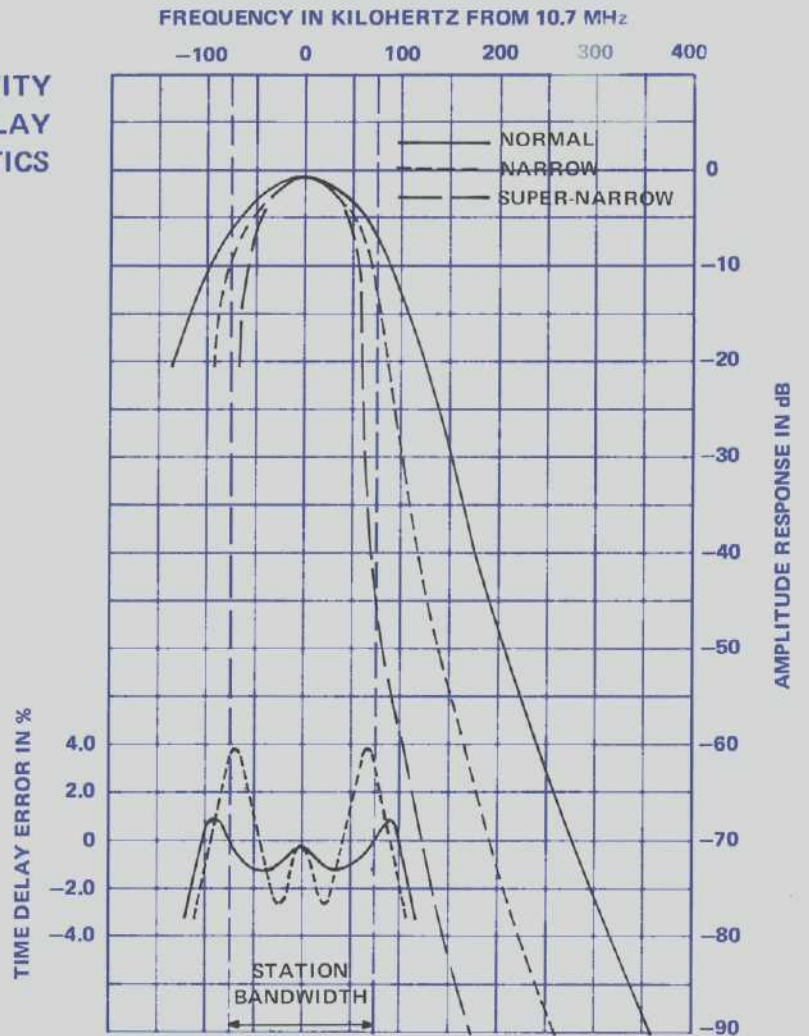

HARMONIC DISTORTION (STEREO AND MONO) AT NORMAL SELECTIVITY

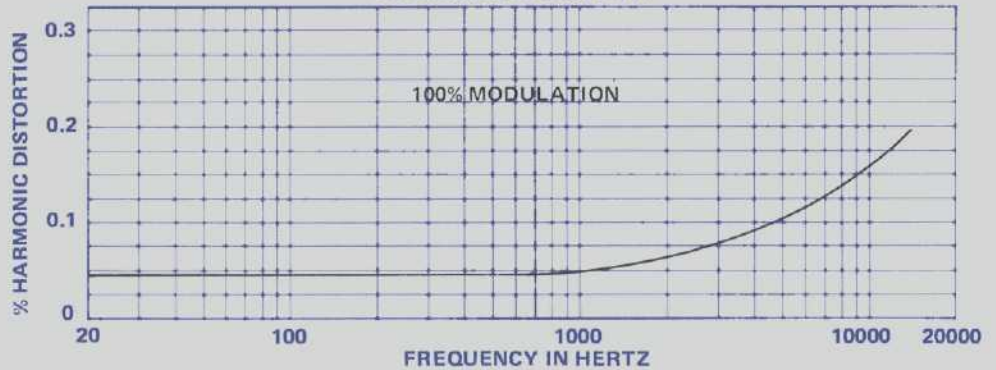

INTERMODULATION DISTORTION (STEREO AND MONO) AT NORMAL SELECTIVITY

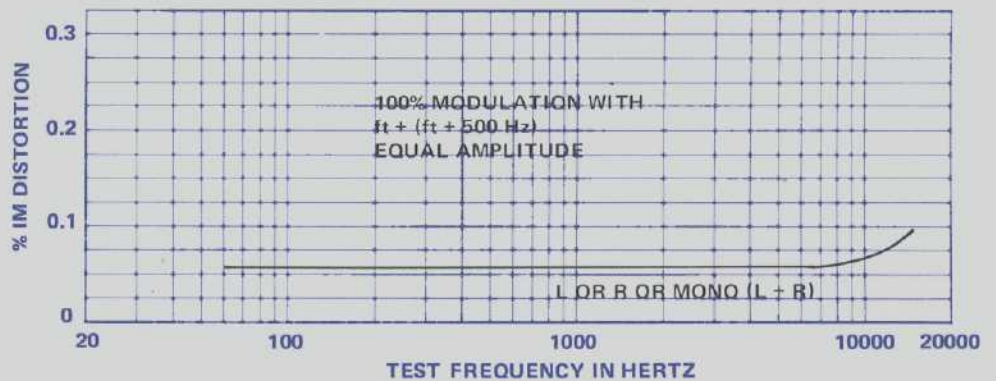



# Typical Performance Charts

STEREO SEPARATION LIMITS  
AT NORMAL SELECTIVITY

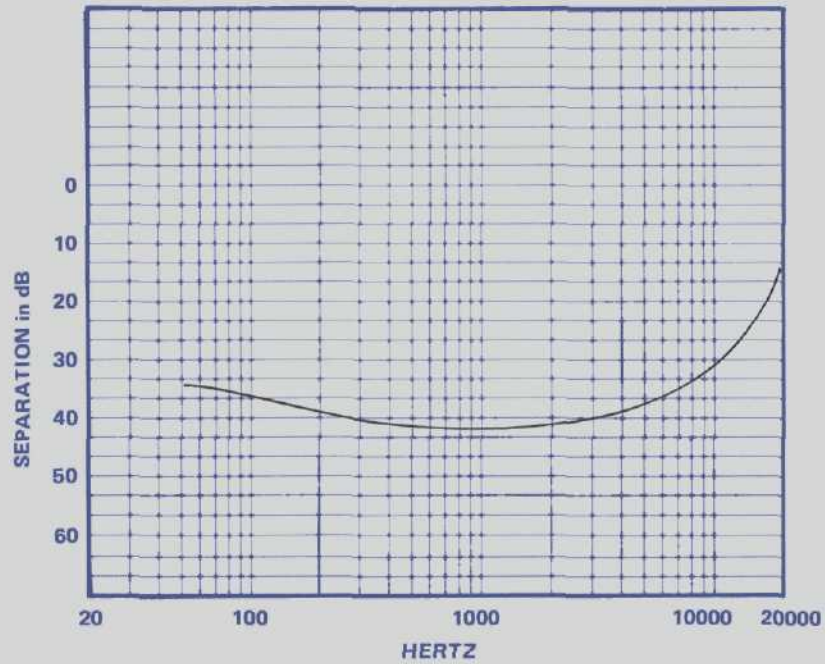

SIGNAL PERFORMANCE  
AT NORMAL SELECTIVITY

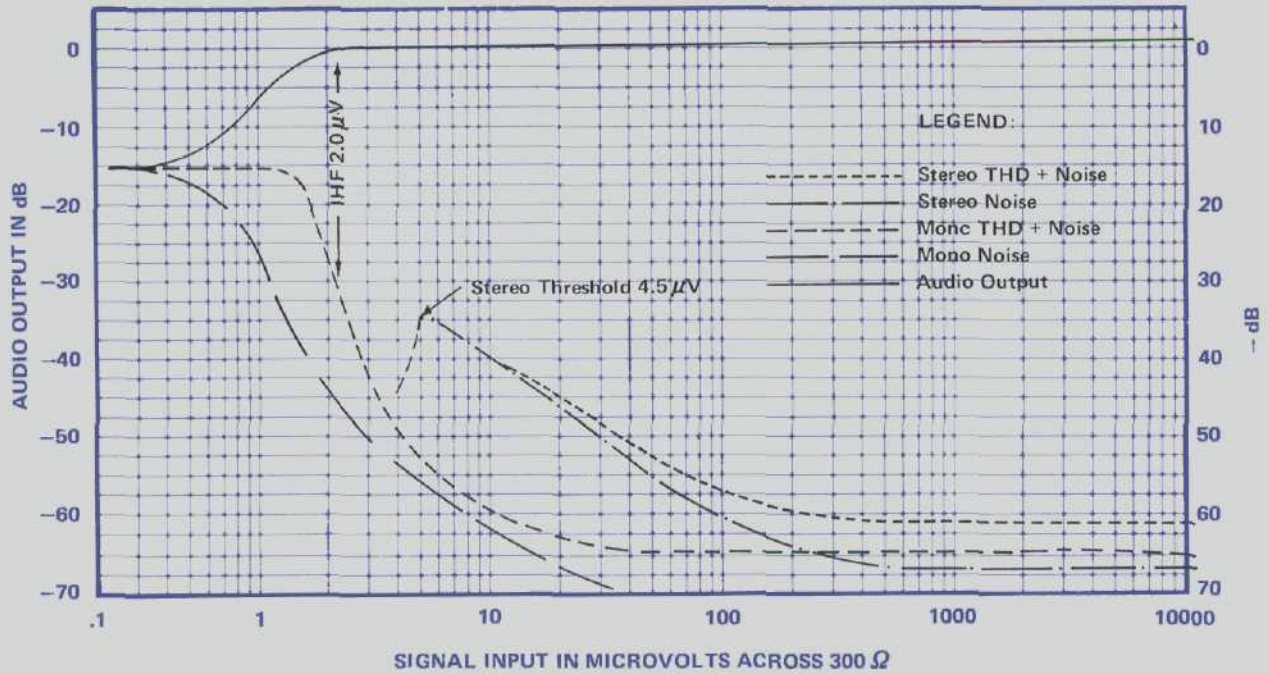



# Technical Description

## TUNING MECHANISM AND DIAL DRIVE

In the MR 78, the unique design and careful manufacture of the mechanical dial drive assembly gives smooth flywheel tuning.

By controlling the relationship of mass and mechanical resistance, and by dividing the workloads in the dial drive system, it becomes nearly impossible to detect any backlash. Yet, the entire dial drive is a model of mechanical stability.

For added ease and increased tuning accuracy, a section of the dial pointer is illuminated.

## FRONT END

FM signals enter the tuner through the antenna terminals. A coaxial cable conducts the signal to the RF amplifier. In the amplifier the stations are separated, amplified, and converted to a common 10.7 MHz IF frequency. Instead of using a conventional easily overloaded transistor or FET as a straight RF amplifier, the MR 78 uses a rugged Junction Field Effect Transistor as an impedance converter to drive a 5-watt power transistor. This combination (a cascode circuit) makes the RF amplifier virtually impossible to overload or cross-modulate. As an example, if you are tuned to a 3 microvolt signal at 96.3 MHz, the MR 78 will reject signals elsewhere on the dial which are at least 4,000,000 times stronger. Thus, a 12 volt signal received at 104.3 MHz would not bother the signal at 96.3 MHz. When tuned to 104.3 MHz, the tuner will not overload. All MR 78 tuners must pass the 12 volt overload test.

The MR 78 has an antenna matching circuit in the RF input. In fringe areas a broad low-loss RF circuit

provides maximum sensitivity for a low-gain antenna. In metropolitan areas crowded with many strong signals, a sharp RF input circuit greatly reduces spurious responses and achieves maximum sensitivity when connected to a high-gain antenna.

The RF bandpass of the antenna matching circuit can be modified by switching the resonator L1 C1 in or out of the circuit. Broad band pass is obtained by setting the ANTENNA MATCHING switch to the LOW GAIN ANT. position. This connects +24 volts to the circuit turning diode D1 off and diodes D2, D3 on. In this configuration the antenna is connected directly to the RF amplifier input resonator L2 C2. Diode D3 is tapped on L2 to yield optimum noise, while D2 shorts resonator L1 C1 so its loss is not coupled into the circuit.

Sharp bandpass is obtained by setting the ANTENNA MATCHING switch to the HIGH GAIN ANT. position. This connects -12 volts to the circuit, turning diode D1 on and diodes D2, D3 off. The RF input circuit becomes a double tuned filter with high Q in both resonators, which provides sharp bandpass. Diode D1 is tapped on L1 to yield optimum selectivity. The oscillograph below shows the two bandpass curves of the RF input circuit.

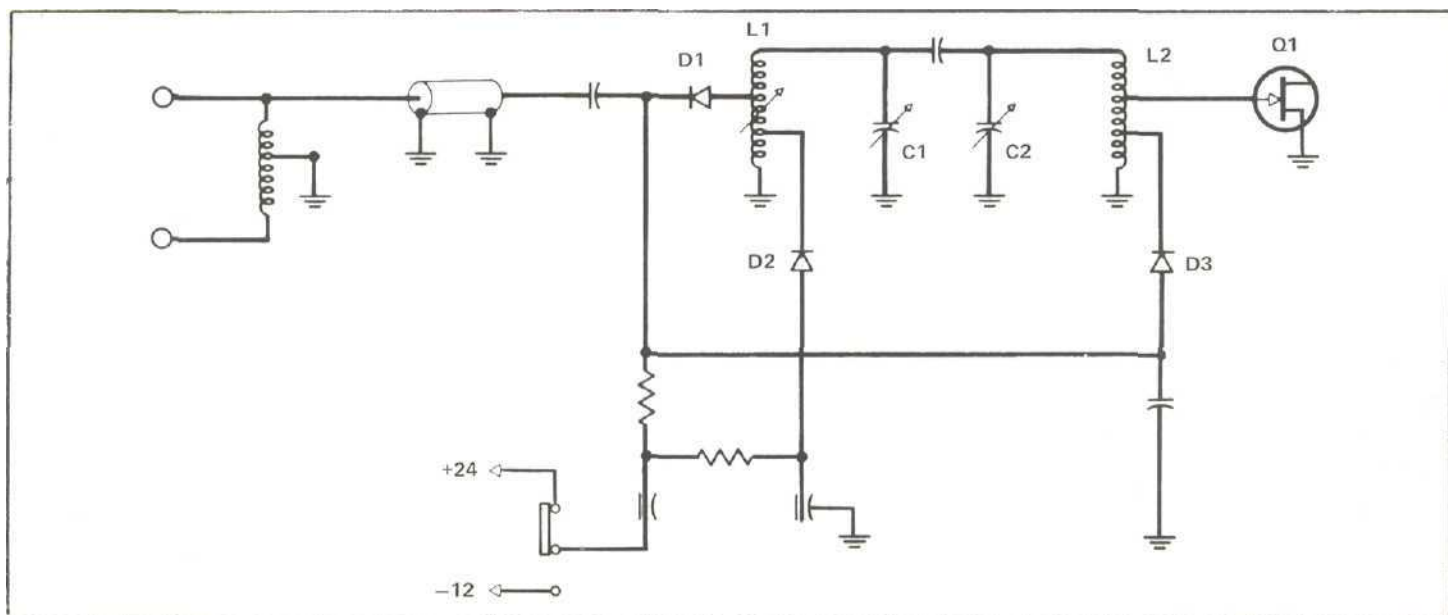
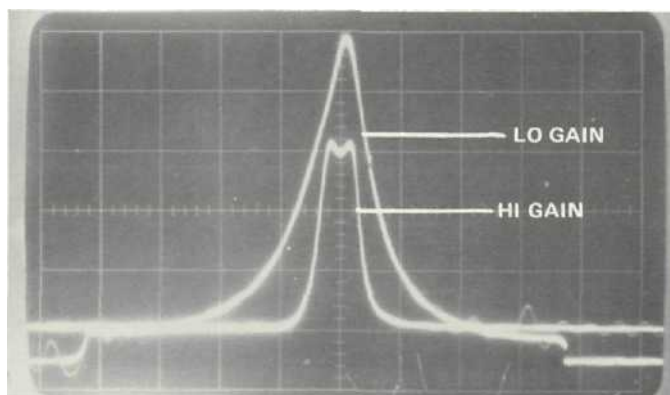

Another new design in the MR 78 front end is the integrated circuit balanced mixer. This mixer is practically impossible to overload. Oscillator pulling, crossmodulation, and other types of distortion so common in ordinary transistor or FET mixers is minimized. A balanced bifilar transformer couples the 10.7 MHz output to the IF amplifier.

Completing the MR 78 front end is the oscillator. It uses a high-Q ceramic form tank coil. The oscillator is free from spurious radiations, and operates at high efficiency. AFC is not required.

### RIMO FILTER IF AMPLIFIER

The MR 78 uses linear-phase IF filters. The Rimo filter, designed from a FORTRAN computer program, is the most general class of minimum-phase constant-delay filter. The filter design has great mathematical complexity. Using numerical integration in the S-plane, an "IBM" 1130 high speed computer spent eighteen minutes on the mathematics for the design of the IF filter. It would have taken an engineer, working twenty-four hours a day, seven days a week, and working error-free three-hundred years to perform the same mathematical calculations.

The Rimo filter has flat time delay in its pass band region. Any error in time delay causes FM distortion. All other IF filters have delay distortion, as much as 100%. The MR 78 filter has less than 1.0% delay distortion from antenna input to discriminator output.

Constant delay in the IF filter bandpass (which is equivalent to linear phase) is essential for low distortion FM reception. The MR 78 tuner uses linear phase (Rimo) filters at NORMAL and NARROW positions of the SELECTIVITY switch settings.

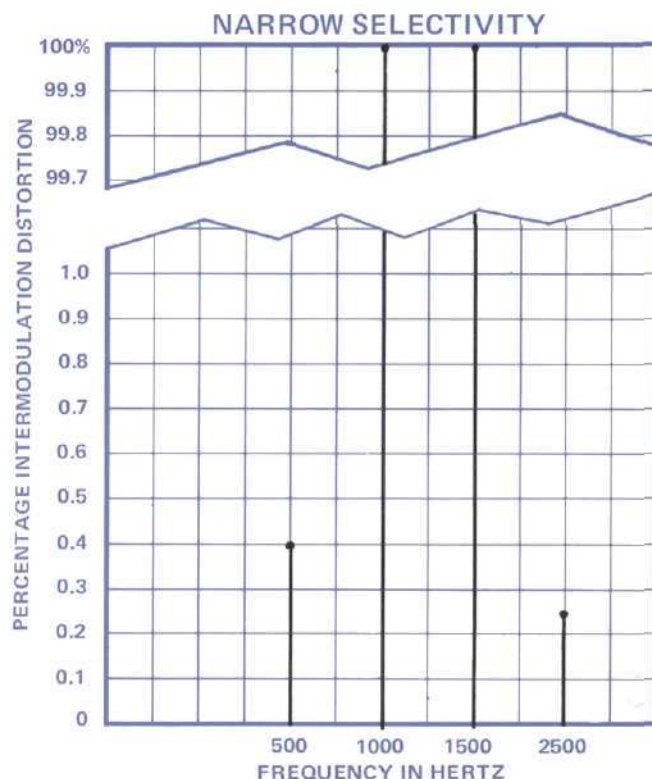

For almost all reception conditions the tuner provides stereo signals that have the lowest possible distortion.

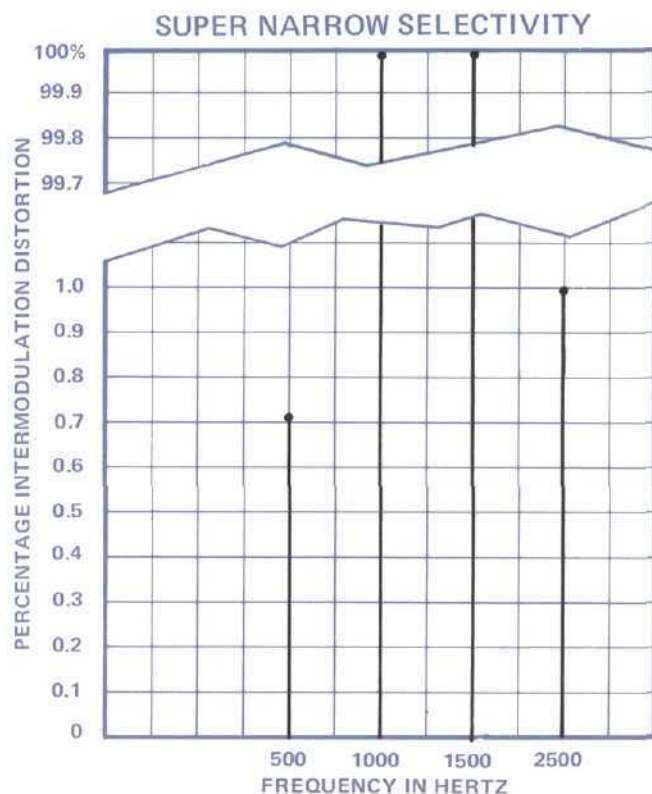

Constant delay design techniques are used in the 4-pole 4-zero crystal filter used in the SUPER NARROW position. However due to the extreme selectivity offered, delay distortion is very slightly increased over the other selectivity positions.

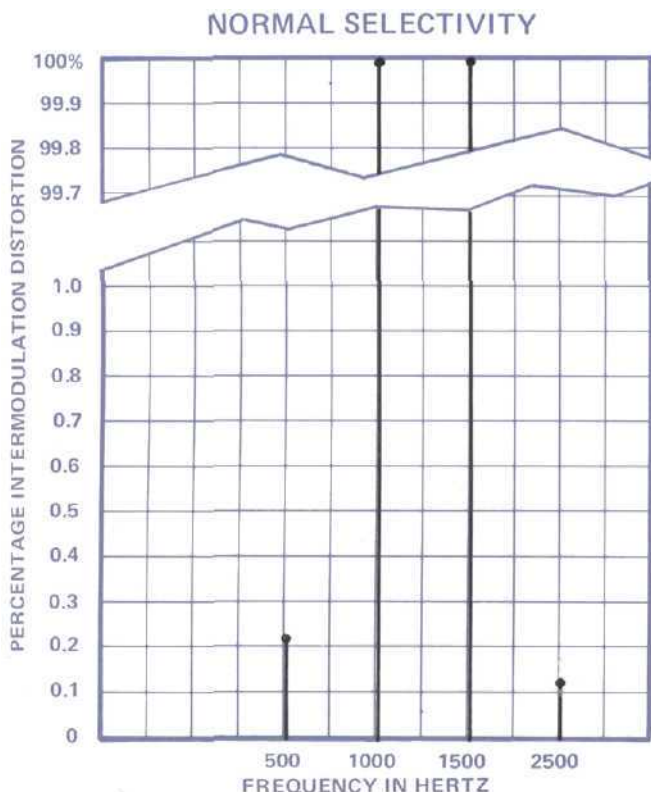

The MR 78 has the narrowest IF bandwidth ever used in a stereo tuner. It is the correct width to let just one FM station through.

The excellent selectivity of the MR 78 (210 kHz wide at 60dB down) permits tuning stations that are impossible to receive on ordinary tuners.

### LINEAR-PHASE BRIDGE DISCRIMINATOR

The advantages of the Rimo filter would be lost if it had to work into an ordinary FM detector. A new detector had to be developed. It is the linear phase bridge discriminator. The linear-phase bridge discriminator uses a balanced transmission line bridge in conjunction with a differential voltage-doubling rectifier to achieve nearly distortionless demodulation of FM signals. McIntosh has a US patent on this new FM detector.

The resistors R1 and R3 form a Wheatstone bridge in combination with the two transmission line sections. The RF voltages E1 and E2 at the junctions of the resistors and the transmission lines will vary with frequency in such a manner that their RMS **arithmetic difference** ( $E_1 - E_2$ ) is a straight-line function. Thus these RF voltages are peak rectified by an amplitude detector, and the difference taken, producing a distortionless recovery of the FM information.

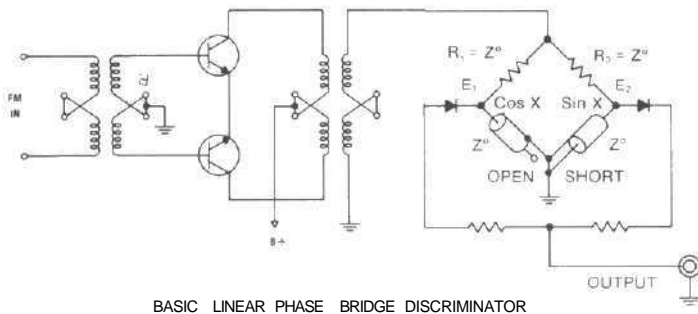

BASIC LINEAR PHASE BRIDGE DISCRIMINATOR

Performance of the MR 78 bridge discriminator has reduced distortion to nearly the theoretical zero. In addition to its excellent distortion-free performance, the bridge discriminator also exhibits a capture ratio close to 0 dB.

### STEREO DECODER

An integrated circuit audio amplifier with over 120 dB of negative feedback in two loops is used to drive the stereo demodulator. This new circuit keeps the distortion low in the stereo mode of operation. Highly stable pilot recovery circuits are used to minimize 19,000 Hz intermodulation beats. MUTING, STEREO ONLY, and AUTOMATIC STEREO/MONO switching are functions performed within the stereo decoder.

The STEREO FILTER is connected in the audio amplifier to reduce noise when listening to weak stereo stations. Careful design of the STEREO FILTER circuit permits an ideal compromise between channel separation and noise rejection.

Ordinary stereo filters use a single capacitor. The MR 78 uses an elaborate twin-T bandpass filter. This circuit is much more effective in suppressing noise and still preserving the stereo image.

### AUDIO PREAMPLIFIER SECTION

The audio amplifier increases the level of the program adequate to drive a preamplifier or other accessory equipment. It consists of two, two-transistor amplifiers, one for each channel. The design uses considerable negative feedback to help achieve low distortion, wide frequency response, and excellent stability. Each audio amplifier delivers 2.5 volts to the FIXED OUTPUT jacks. A second pair of outputs are available where level can be varied by the VOLUME control.

### POWER SUPPLY

Special design attention has been given to the power supply section. Two separate power circuits are used. The first is a 24 volt regulated supply.

The 24volt regulator uses electronic filtering to insure the lowest possible background hum level, maximum stability and extremely good regulation. All signal stages are powered from this regulator.

The second is a half wave rectifier with electronic filter which supplies DC to the multiplex decoder.

# Block Diagram

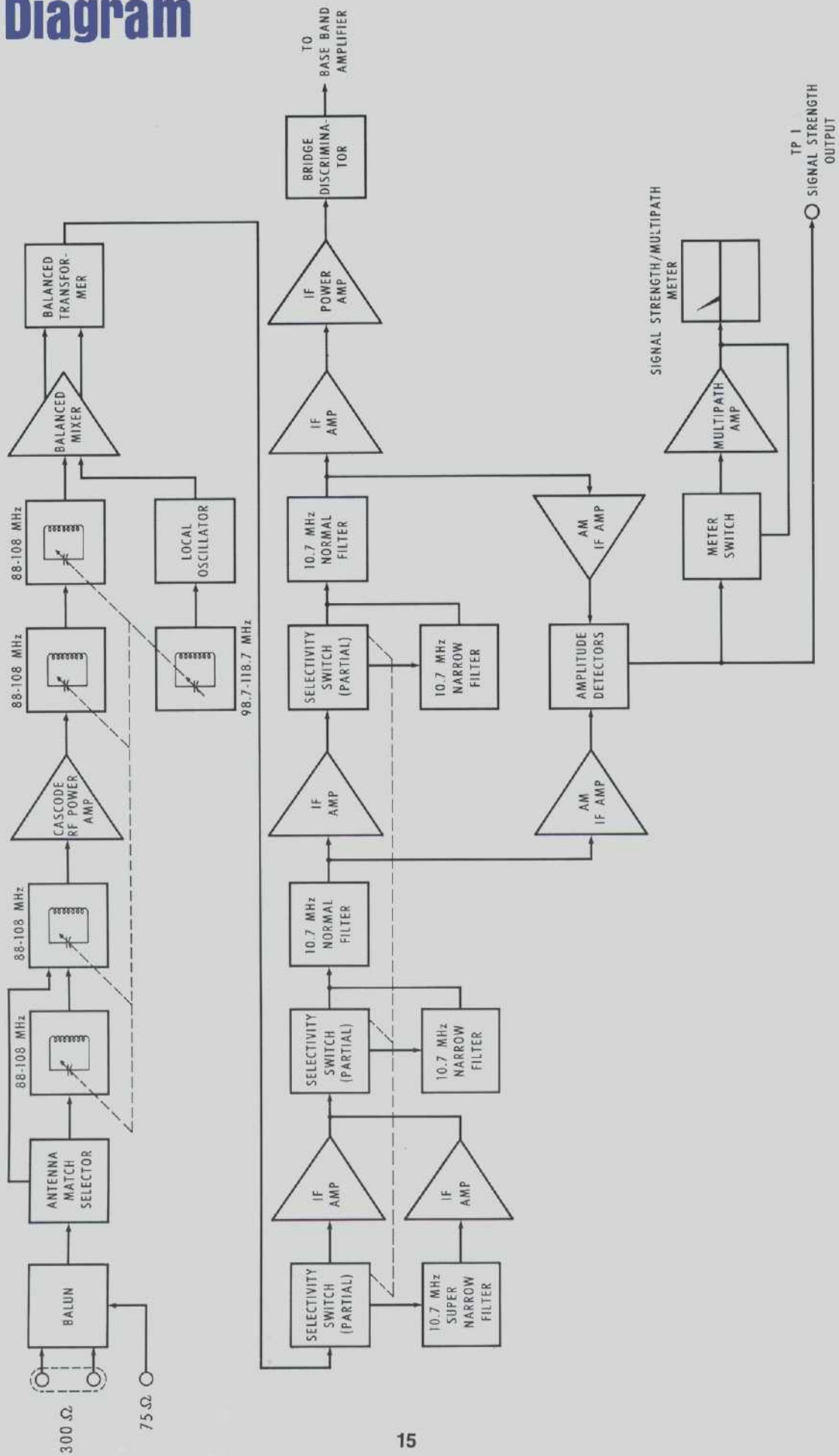

RF & IF SECTION

# Block Diagram

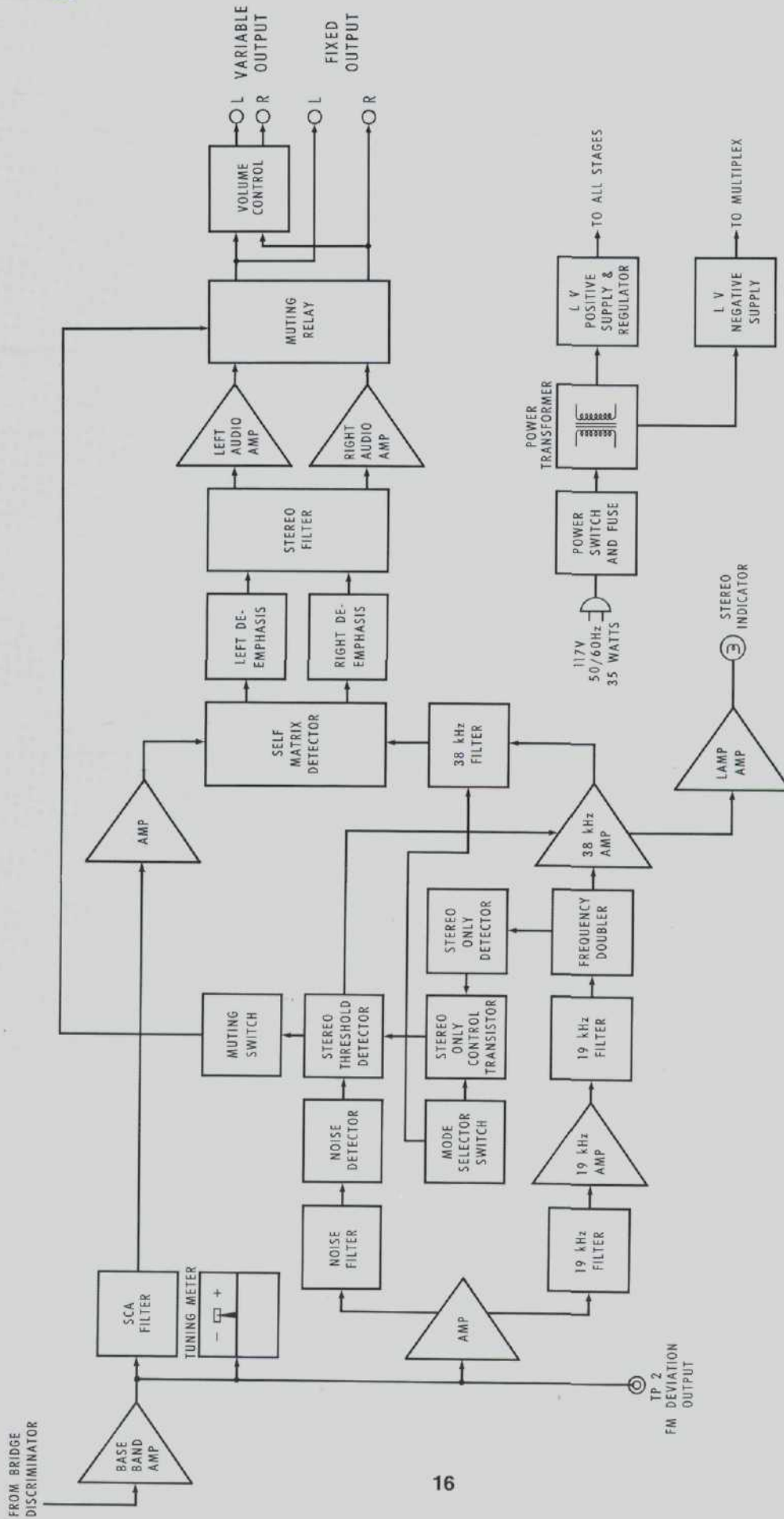

MULTIPLEX AND AUDIO SECTION





# McIntosh

**McINTOSH LABORATORY INC.**

**2 CHAMBERS ST., BINGHAMTON, N. Y. 13903**

**607-723-3512**

Design subject to change without notice.

Printed in U.S.A.

038-580